

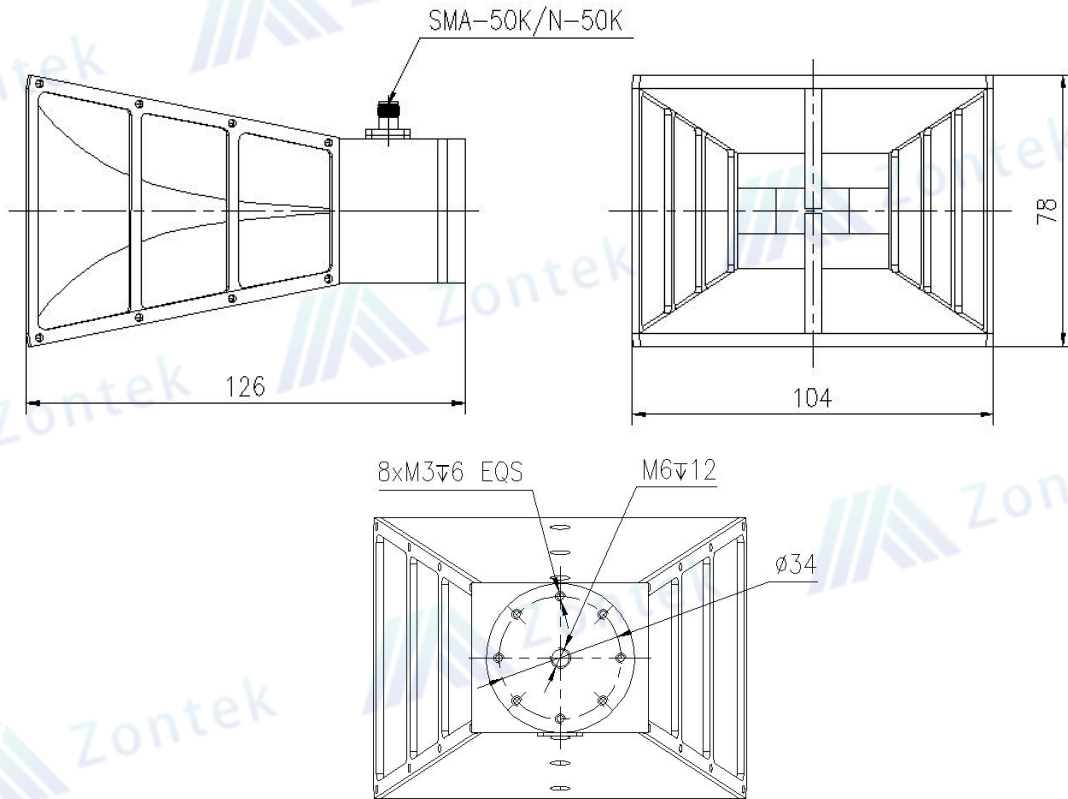

Technical Specification		
Broadband Horn Antenna		
Item	Specification	Unit
Model	ZK-KDLB20180	
Frequency Range	2-18	GHz
Gain	12 Typ.	dB
VSWR	1.5 Typ.	
Polarization	Linear	
Connector	N-50K	
Power Handing(W)	150 Max	
Material	Al	
Color	Grey	
Size	126*104*78	mm



Outline Drawing:



VSWR:

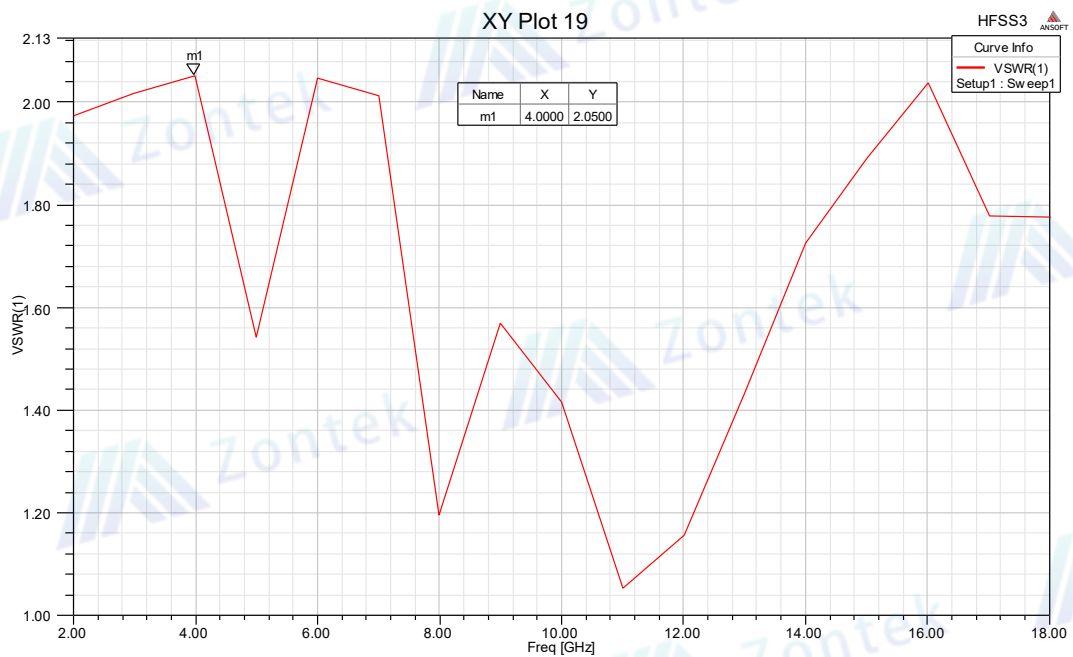



Chengdu Zontek Technology Co.,Ltd.

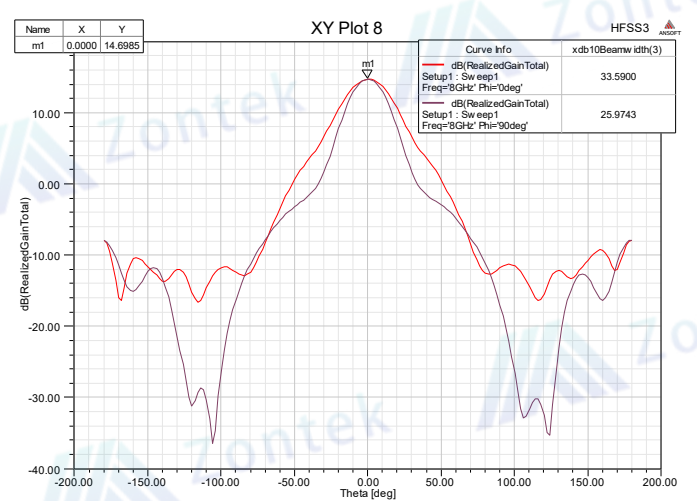
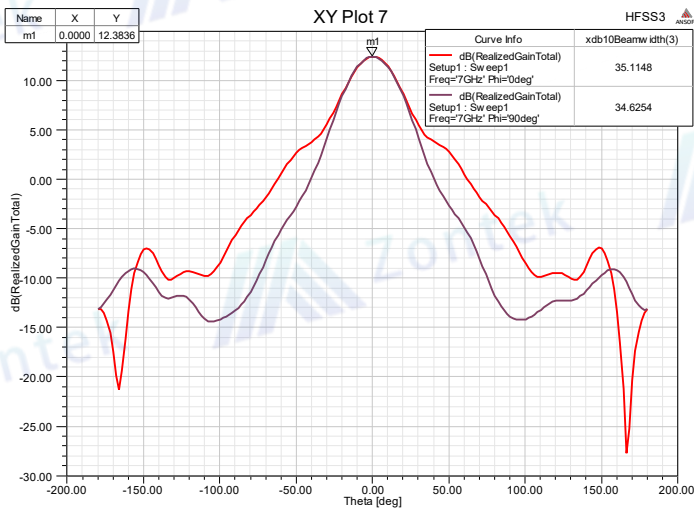
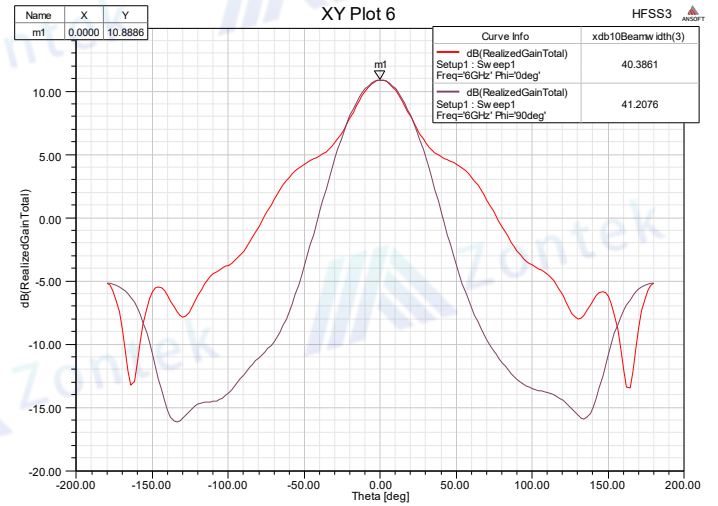
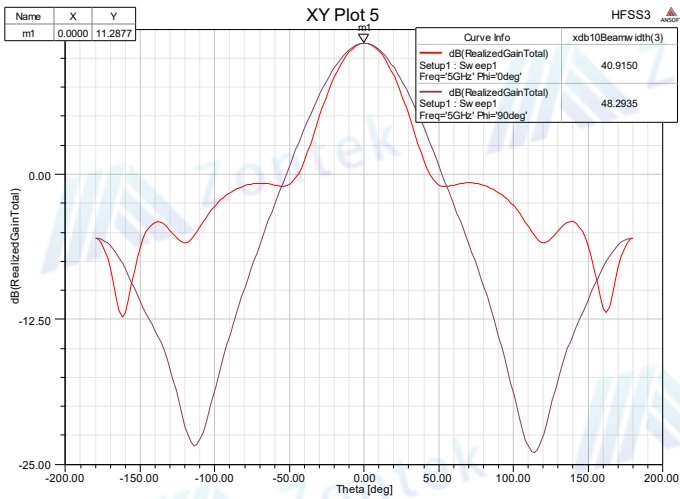
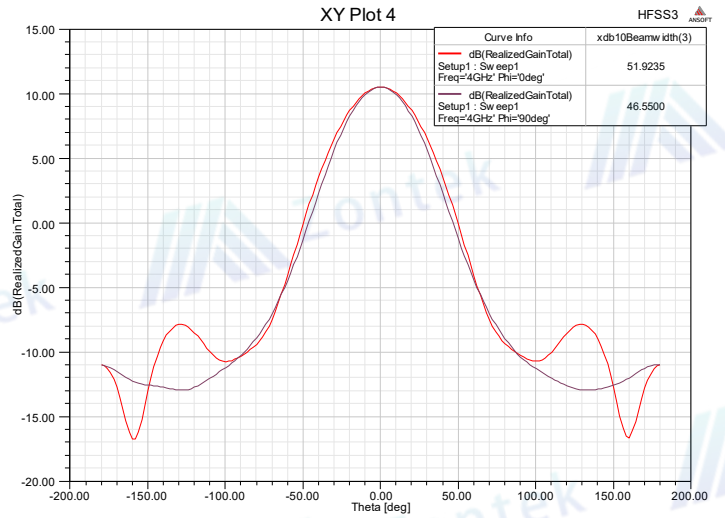
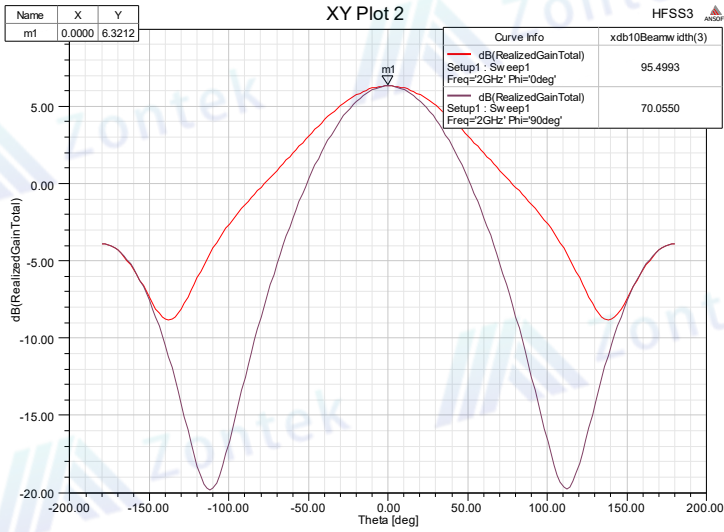

Website: www.a-microem.com Email: salesdirector@a-microem.com Tel: (+86) 028-89541190
 Data for reference only, for more information, please contact: salesdirector@a-microem.com



Chengdu Zontek Technology Co.,Ltd.

